

# Ruijie Reyee RG-RAP62-OD Access Point

## Installation Guide



## Copyright

Copyright © 2024 Ruijie Networks

All rights are reserved in this document and this statement.

Without the prior written consent of Ruijie Networks, any organization or individual shall not reproduce, extract, back up, modify, or propagate the content of this document in any manner or in any form, or translate it into other languages or use some or all parts of the document for commercial purposes.

 and other Ruijie networks logos are trademarks of Ruijie Networks.

All other trademarks or registered trademarks mentioned in this document are owned by their respective owners.

## Disclaimer

The products, services, or features you purchase are subject to commercial contracts and terms, and some or all of the products, services, or features described in this document may not be available for you to purchase or use. Except for the agreement in the contract, Ruijie Networks makes no explicit or implicit statements or warranties with respect to the content of this document.

The names, links, descriptions, screenshots, and any other information regarding third-party software mentioned in this document are provided for your reference only. Ruijie Networks does not explicitly or implicitly endorse or recommend the use of any third-party software and does not make any assurances or guarantees concerning the applicability, security, or legality of such software. You should choose and use third-party software based on your business requirements and obtain proper authorization. Ruijie Networks assumes no liability for any risks or damages arising from your use of third-party software.

The content of this document will be updated from time to time due to product version upgrades or other reasons, Ruijie Networks reserves the right to modify the content of the document without any notice or prompt.

This manual is designed merely as a user guide. Ruijie Networks has tried its best to ensure the accuracy and reliability of the content when compiling this manual, but it does not guarantee that the content of the manual is completely free of errors or omissions, and all the information in this manual does not constitute any explicit or implicit warranties.

# Preface

## Audience

This document is intended for:

- Network engineers
- Technical support and servicing engineers
- Network administrators

## Technical Support

- Official Website of Ruijie Reye: <https://reyee.ruijie.com>
- Technical Support Website: <https://reyee.ruijie.com/en-global/support>
- Case Portal: <https://www.ruijienetworks.com/support/caseportal>
- Community: <https://community.ruijienetworks.com>
- Technical Support Email: [service\\_rj@ruijienetworks.com](mailto:service_rj@ruijienetworks.com)
- Online Robot/Live Chat: <https://reyee.ruijie.com/en-global/rita>

## Conventions

### 1. GUI Symbols

Interface symbol	Description	Example
<b>Boldface</b>	1. Button names 2. Window names, tab name, field name and menu items 3. Link	1. Click <b>OK</b> . 2. Select <b>Config Wizard</b> . 3. Click the <b>Download File</b> link.
>	Multi-level menus items	Select <b>System &gt; Time</b> .

### 2. Signs

The signs used in this document are described as follows:

 **Danger**  
An alert that calls attention to safety instruction that if not understood or followed can result in personal injury.

---

 **Warning**  
An alert that calls attention to important rules and information that if not understood or followed can result in data loss or equipment damage.

---

 **Caution**  
An alert that calls attention to essential information that if not understood or followed can result in function failure or performance degradation.

---

---

 **Note**

An alert that contains additional or supplementary information that if not understood or followed will not lead to serious consequences.

---

---

 **Specification**

An alert that contains a description of product or version support.

---

**3. Note**

This manual provides installation steps, troubleshooting, technical specifications, and usage guidelines for cables and connectors. It is intended for users who want to understand the above and have extensive experience in network deployment and management, and assume that users are familiar with related terms and concepts.

# Contents

Preface .....	1
1 Product Overview .....	1
1.1 About the RG-RAP62-OD .....	1
1.2 Package Contents .....	1
1.3 Product Appearance .....	2
1.3.1 Appearance .....	2
1.3.2 Port and Button .....	3
1.4 Technical Specifications .....	4
1.5 Power Supply Technical Specifications .....	6
1.6 Cooling .....	7
2 Preparing for Installation .....	8
2.1 Safety Precautions .....	8
2.1.1 General Safety Precautions .....	8
2.1.2 Handling Safety .....	8
2.1.3 Electrical Safety .....	8
2.2 Installation Environment Requirements .....	9
2.2.1 Bearing .....	9
2.2.2 Ventilation .....	9
2.2.3 Temperature and Humidity .....	9
2.2.4 EMI .....	9
2.3 Tools .....	10
3 Installing the AP .....	11
3.1 Installation Flowchart .....	11

3.2 Before You Begin.....	11
3.3 Safety Precautions During Installation .....	12
3.4 Installing the AP .....	12
3.4.1 Installing the AP .....	12
3.4.2 Mounting the AP on a Wall.....	13
3.4.3 Mounting the AP on a Pole .....	15
3.5 Bundling Cables.....	15
3.5.1 Precautions .....	15
3.5.2 Bundling Steps.....	15
3.6 Checklist After Installation .....	16
4 Debugging .....	17
4.1 Setting Up the Configuration Environment .....	17
4.2 Powering on the AP .....	17
4.2.1 Checklist Before Power-On .....	17
4.2.2 Checklist After Power-on .....	17
4.3 Logging in to the Web GUI .....	17
5 Monitoring and Maintenance.....	18
5.1 Monitoring .....	18
5.2 Maintenance .....	18
6 Troubleshooting.....	19
6.1 General Troubleshooting Flowchart .....	19
6.2 Common Faults.....	19
7 Appendixes.....	21
7.1 Connectors and Media.....	21

7.1.1 2500BASE-T/1000BASE-T/100BASE-TX .....	21
7.2 Cabling Recommendations.....	22

# 1 Product Overview

## 1.1 About the RG-RAP62-OD

The RG-RAP62-OD 3000M dual-band gigabit wireless access point (AP) is launched by Ruijie Reyee for Wi-Fi coverage. Supporting the IEEE 802.11 a/b/g/n/ac/ax protocols and the MIMO technology, this AP can operate in both 2.4 GHz and 5 GHz frequency bands, delivering a maximum data rate of 573 Mbps in the 2.4 GHz band and 2401 Mbps in the 5 GHz band. The RG-RAP62-OD features one 1 Gbps port supporting IEEE 802.3af/at-compliant PoE and 24 V passive PoE for power input.

The RG-RAP62-OD is designed with an IP65-rated casing, making it ideal for deployment in challenging environments. This effectively shields it from harsh weather and environmental conditions.

## 1.2 Package Contents

Table 1-1 Package Contents

No.	Item	Quantity
1	RG-RAP62-OD Access Point	1
2	Mounting Plate	1
3	Cable Tie (7.6 mm x 300 mm [0.30 in. x 11.81 in.])	2
5	Phillips Pan Head Screw (ST2.9 x 20 PA)	2
6	Wall Anchor (Diameter: 5 mm [0.20 in.], Length: 24 mm [0.94 in.])	2
7	User Manual	1
8	Warranty Card	1

---

 **Note**

The package contents generally contain the preceding items. The actual delivery is subject to the order contract. Please check your goods carefully against the order contract. If you have any questions, please contact the distributor.

---



## 1.3 Product Appearance

### 1.3.1 Appearance

Figure 1-1 Appearance



### 1.3.2 Port and Button

Figure 1-2 Port and Button

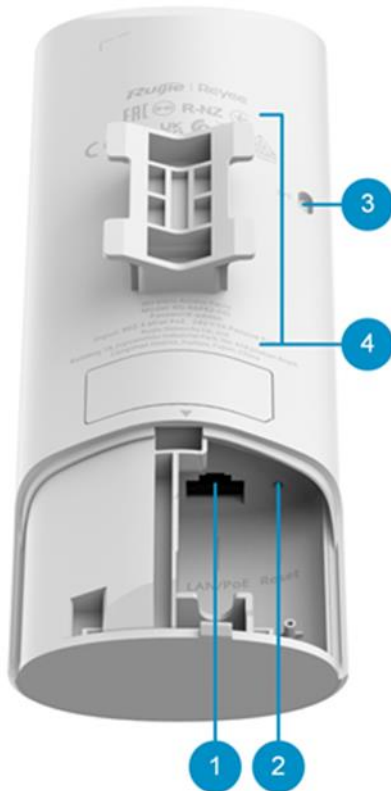

Table 1-2 Components on the Rear Panel

No.	Component	Description
1	LAN/PoE port	1 x 10/100/1000 BASE-T port with auto-negotiation, PoE-capable.
2	Reset button	<ul style="list-style-type: none"> <li>● Press and hold for less than 2 seconds: Restart the device.</li> <li>● Press and hold for more than 5 seconds: Restore the device to factory settings.</li> </ul>
4	Label	The label is located on the back of the device.

Table 1-3 LED

No.	Status	Description
3	Off	The device is not receiving power.
	Slow blinking blue	The device is operating but an alarm is generated.
	Fast blinking blue	Possible cases: <ul style="list-style-type: none"> <li>● The device is resetting.</li> <li>● The device is upgrading.</li> </ul>

No.	Status	Description
		<ul style="list-style-type: none"> <li>● The device is recovering.</li> <li>● The device is starting up.</li> </ul> Note: Do not power off the device when the LED is in this state.
	Solid blue	The device is operating properly and no alarm is generated.

## 1.4 Technical Specifications

Table 1-4 Specifications

<b>Radio Design</b>	Dual-band, dual-stream
<b>Wi-Fi Standards</b>	IEEE 802.11ax, IEEE 802.11ac Wave 1 and Wave 2, and IEEE 802.11a/b/g/n
<b>Operating Frequency Bands</b>	IEEE 802.11b/g/n/ax: 2.4 GHz to 2.4835 GHz IEEE 802.11a/n/ac/ax: 5.150 GHz to 5.350 GHz, 5.470 GHz to 5.7250 GHz, 5.725 GHz to 5.850 GHz
<b>Antenna Type</b>	Built-in directional antenna (2.4 GHz: Ant1: 3.0 dBi, Ant2: 4.0 dBi; 5 GHz: Ant1: 6.3 dBi, Ant2: 6.1 dBi, Ant3: 6.5 dBi)
<b>Beam Angle</b>	Omni-directional
<b>Spatial Streams</b>	2.4 GHz: 2 x 2 MIMO 5 GHz: 2 x 2 MIMO
<b>Max. Wi-Fi Speed</b>	2.4 GHz: 573 Mbps 5 GHz: 2401 Mbps Combined: 2974 Mbps
<b>Modulation</b>	OFDM: BPSK@6/9 Mbps, QPSK@12/18 Mbps, 16QAM@24 Mbps, 64QAM@48/54 Mbps DSSS: DBPSK@1 Mbps, DQPSK@2 Mbps, CCK@5.5/11 Mbps MIMO-OFDM: BPSK, QPSK, 16QAM, 64QAM, 256QAM, 1024QAM OFDMA
<b>Receiver Sensitivity</b>	11b: -96 dBm (1 Mbps), -93 dBm (5 Mbps), -89 dBm (11 Mbps) 11a/g: -91 dBm (6 Mbps), -85 dBm (24 Mbps), -80 dBm (36 Mbps), -74 dBm (54 Mbps) 11n: -90 dBm (MCS0), -70 dBm (MCS7), -89 dBm (MCS8), -68 dBm (MCS15) 11ac: 20 MHz: -88 dBm (MCS0), -63 dBm (MCS9) 11ac: 40 MHz: -85 dBm (MCS0), -60 dBm (MCS9) 11ac: 80 MHz: -85 dBm (MCS0), -60 dBm (MCS9)

	<p>11ax: 80 MHz: -82 dBm (MCS0), -57 dBm (MCS9), -52 dBm (MCS11)</p> <p>11ax: 160 MHz: -75 dBm (MCS0), -55 dBm (MCS9), -50 dBm (MCS11)</p>
<b>Max. Transmit Power</b>	<p>Frequency bands and maximum Effective Isotropic Radiated Power (EIRP):</p> <hr/> <p> <b>Note</b></p> <p>Country-specific restrictions apply.</p> <hr/> <ul style="list-style-type: none"> <li>● European Union &amp; United Kingdom: <ul style="list-style-type: none"> <li>○ 2400 MHz to 2483.5 MHz, EIRP ≤ 20 dBm</li> <li>○ 5470 MHz to 5725 MHz, EIRP ≤ 30 dBm</li> </ul> </li> <li>● United States: <ul style="list-style-type: none"> <li>○ 2400 MHz to 2483.5 MHz, max output power ≤ 30 dBm &amp; EIRP ≤ 36 dBm</li> <li>○ 5150 MHz to 5250 MHz, max output power ≤ 30 dBm &amp; EIRP ≤ 36 dBm</li> <li>○ 5250 MHz to 5350 MHz, max output power ≤ 24 dBm &amp; EIRP ≤ 30 dBm</li> <li>○ 5470 MHz to 5725 MHz, max output power ≤ 24 dBm &amp; EIRP ≤ 30 dBm</li> <li>○ 5725 MHz to 5825 MHz, max output power ≤ 30 dBm &amp; EIRP ≤ 36 dBm</li> </ul> </li> <li>● Myanmar: <ul style="list-style-type: none"> <li>○ 2400 MHz to 2483.5 MHz, EIRP ≤ 23 dBm</li> <li>○ 5725 MHz to 5825 MHz, EIRP ≤ 30 dBm</li> </ul> </li> <li>● Thailand: <ul style="list-style-type: none"> <li>○ 2400 MHz to 2483.5 MHz, EIRP ≤ 20 dBm</li> <li>○ 5470 MHz to 5725 MHz, EIRP ≤ 30 dBm</li> <li>○ 5725 MHz to 5825 MHz, EIRP ≤ 30 dBm</li> </ul> </li> <li>● Indonesia: <ul style="list-style-type: none"> <li>○ 2400 MHz to 2483.5 MHz, EIRP ≤ 36 dBm</li> <li>○ 5725 MHz to 5825 MHz, EIRP ≤ 36 dBm</li> </ul> </li> <li>● Egypt: <ul style="list-style-type: none"> <li>○ 2400 MHz to 2483.5 MHz, EIRP ≤ 20 dBm</li> <li>○ 5150 MHz to 5350 MHz, EIRP ≤ 23 dBm</li> </ul> </li> </ul>
<b>Power Step</b>	1 dBm
<b>Dimensions (W x D x H)</b>	200 mm x 70 mm x 35 mm (7.87 in. x 2.76 in. x 1.38 in.) (excluding the mounting plate)
<b>Weight</b>	< 0.4 kg (0.88 lbs.) (excluding the mounting plate)
<b>Service Ports</b>	1 x 10/100/1000BASE-T port with auto-negotiation, PoE-capable
<b>Management Port</b>	N/A
<b>Status LED</b>	1 x system LED (blue)
<b>Power Supply Mode</b>	<ul style="list-style-type: none"> <li>● Standard PoE power supply: IEEE 802.3at (PoE+) (normal operation)</li> <li>● Compatible with IEEE 802.3af (PoE) power supply (the third antenna on the 5 GHz radio is disabled)</li> <li>● Passive 24 V 1 A adapter (normal operation)</li> </ul> <p>For details, see <a href="#">Table 1-5 Relationship Between Power Supply Mode, Data Rate, and Power Input</a>.</p>

<b>Power Supply</b>	<ul style="list-style-type: none"> <li>● IEEE 802.3af/at-compliant PoE power supply</li> <li>● Passive PoE power supply: 24 V = 1 A</li> </ul>
<b>Max. Power Consumption</b>	< 16 W
<b>Bluetooth</b>	Not supported
<b>Environment</b>	Operating temperature: -30°C to +65°C (-22°F to +149°F)
	Storage temperature: -40°C to +75°C (-40°F to +167°F)
	Operating humidity: 5% to 95% RH (non-condensing)
	Storage humidity: 5% to 95% RH (non-condensing)
<b>Mounting</b>	Wall-mount and pole-mount Note: The recommended mounting height ranges from 2.5 m (8.20 ft) to 3 m (9.84 ft).
<b>Surge Protection</b>	4 kV
<b>Certification</b>	CE, FCC, ISED, cTUVus
<b>MTBF</b>	> 400000 hrs

## 1.5 Power Supply Technical Specifications

The RG-RAP62-OD access point supports PoE power supply.

- When standard PoE power supply is used, ensure that the power source equipment (PSE) is at least IEEE 802.3at-compatible. You are advised to use an IEEE 802.3at-compliant PSE in order to optimize the device performance.
- When a 24 V passive PoE adapter is used for power supply, ensure that the adapter supplies an output voltage of 24 V and a maximum output current of 1 A. Use a Ruijie-certified PoE adapter.

The following table lists the relationship between the power supply mode, data rate, and power input.

**Table 1-5 Relationship Between Power Supply Mode, Data Rate, and Power Input**

Power input	Standard PoE power supply: <ul style="list-style-type: none"> <li>● IEEE 802.3at-compliant power supply</li> <li>● IEEE 802.3af-compatible power supply (the third antenna on the 5 GHz radio is disabled)</li> </ul> 24 V passive PoE adapter: 24 V = 1A			
Power supply mode	2.4 GHz	5 GHz	Combined rate	Power consumption
IEEE 802.3at-compliant power supply (recommended)	2 x 2	3 x 3	2976 Mbps	≤ 16 W
24 V/1 A passive PoE adapter	2 x 2	3 x 3	2976 Mbps	≤ 16 W

IEEE 802.3af-compatible power supply	2 x 2	2 x 2	2976 mbps (Wi-Fi performance and coverage degrade.)	$\leq 13.5$ W
--------------------------------------	-------	-------	--	---------------

## 1.6 Cooling

The RG-RAP62-OD access point adopts a fanless design. Therefore, a sufficient clearance must be maintained around the device for cooling.

# 2 Preparing for Installation

## 2.1 Safety Precautions

---

### Note

- To prevent device damage and physical injury, please read the safety precautions carefully in this chapter.
  - The following safety precautions do not cover all possible hazardous situations.
- 

### 2.1.1 General Safety Precautions

- Do not expose the AP to high temperature, dusts, or harmful gases.
  - Do not install the AP in an inflammable or explosive environment.
  - Keep the AP away from Electro-Magnetic Interference (EMI) sources such as large radar stations, radio stations, and substations.
  - Do not subject the AP to unstable voltage, vibration, and noises.
  - The installation site should be dry. Keep the AP at least 500 meters (1,640.41 ft.) away from the ocean and do not face it towards the sea breeze.
  - The installation site should be free from water, including possible flooding, seepage, dripping, or condensation. The installation site should be selected according to network planning and communications equipment features, and considerations such as climate, hydrology, geology, earthquake, electrical power, and transportation.
  - Ensure that the AP and the power distribution system are properly grounded.
- 

### Caution

Follow the installation instructions in the user manual to correctly install or remove the AP.

---

### 2.1.2 Handling Safety

- Avoid handling the AP frequently.
- Turn off all power supplies and unplug all power cables before you handle the AP.

### 2.1.3 Electrical Safety

---

#### Warning

- Improper or incorrect electrical operation can cause an accident such as fire or electric shock, thus causing severe even fatal damages to humans and devices.
  - Direct or indirect contact with a wet object (or your finger) on the high voltage and power line can be fatal.
- 
- Observe local regulations and specifications when performing electrical operations. Relevant operators must be qualified.
  - Carefully check for any potential hazards in the working area such as damp/wet ground or floors.

- Find the location of the emergency power supply switch in the room before installation. Cut off the power supply first in case of an accident.
- Be sure to make a careful check before shutting down the power supply.
- Keep the AP far away from grounding or lightning protection devices for power equipment.
- Keep the AP away from radio stations, radar stations, high-frequency high-current devices, and microwave ovens.

## 2.2 Installation Environment Requirements

For normal operation and prolonged service life of the access point, the installation site must meet the following requirements.

### 2.2.1 Bearing

Evaluate the weight of the device and its accessories, and ensure that the installation site (such as the wall or pole) can bear the weight.

### 2.2.2 Ventilation

The AP adopts natural cooling. Reserve a sufficient clearance around the AP to ensure proper ventilation.

### 2.2.3 Temperature and Humidity

To ensure the normal operation and service life of the AP, maintain appropriate temperature and humidity in the equipment room. Improper room temperature and humidity can cause damage to the AP.

- High relative humidity may affect insulation materials, resulting in poor insulation and even electrical leakage. Sometimes it may lead to changes in the mechanical properties of materials and corrosion of metal parts.
- Low relative humidity can dry and shrink insulation sheets and cause static electricity that can damage the circuitry.
- High temperatures greatly reduce device reliability and shorten service life.

**Table 2-1 Temperature and Humidity Requirements**

Temperature	Humidity
-30°C to +65°C (-22°F to +149°F)	0% to 100% RH (non-condensing)

### 2.2.4 EMI

- Keep the AP as far away from the grounding equipment of the power device and the lightning prevention equipment as possible.
- Keep the AP away from radio stations, radar stations, high-frequency high-current devices, and microwave ovens.



## 2.3 Tools

Table 2-2 Tools

<b>Common Tools</b>	Phillips screwdriver, hex wrench, cables, Ethernet cable, cage nut, diagonal plier, cable ties
<b>Special Tools</b>	ESD gloves, wire stripper, crimping plier, RJ45 crimping plier, wire cutter, and waterproof adhesive tape
<b>Meters</b>	Multimeter
<b>Relevant Devices</b>	PC, display, and keyboard

---

 **Note**

The RG-RAP62-OD is delivered without a tool kit. The tool kit is customer-supplied.

---

# 3 Installing the AP

## ⚠ Caution

Before installing the AP, make sure that you have carefully read the requirements described in Chapter 2.

## 3.1 Installation Flowchart

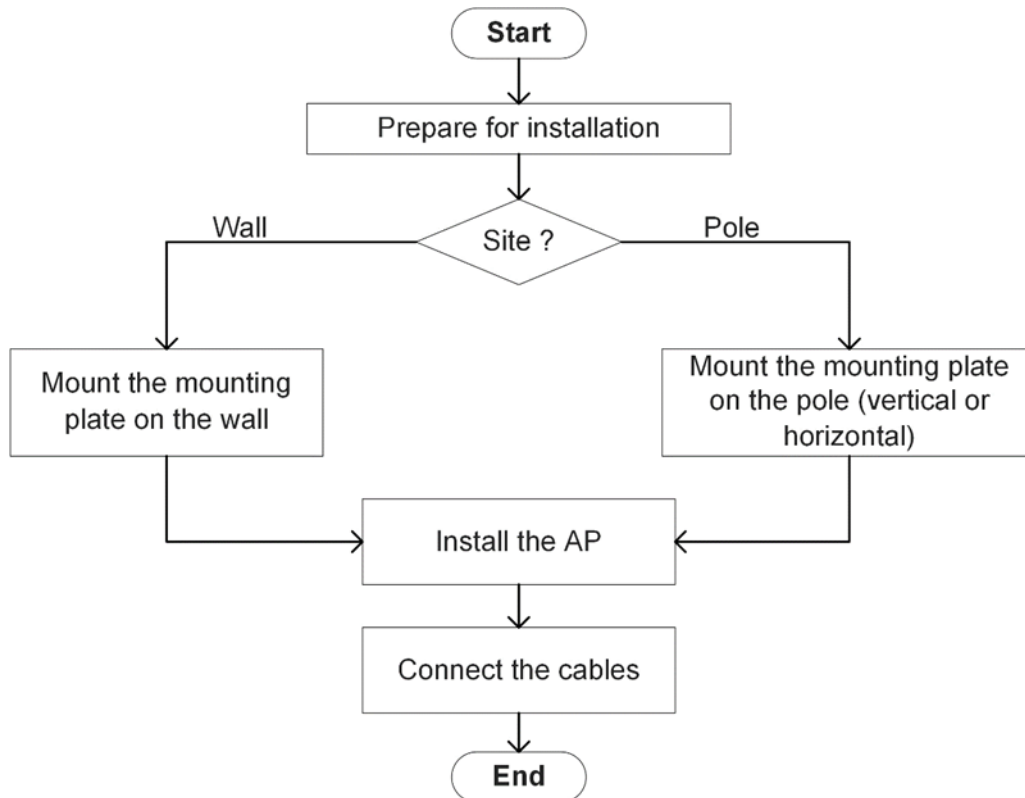

## 3.2 Before You Begin

Carefully plan and arrange the installation position, networking mode, power supply, and cabling before installation. Confirm the following requirements before installation:

- The installation site provides sufficient space for proper ventilation.
- The installation site meets the temperature and humidity requirements of the AP.
- The power supply and required current are available in the installation site.
- The selected power supply modules meet the system power requirements.
- The installation site meets the cabling requirements of the AP.
- The installation site meets the site requirements of the AP.
- The customized AP meets the client-specific requirements.

### 3.3 Safety Precautions During Installation

This AP can be mounted on a wall or a pole with a diameter ranging from 40 mm to 70 mm (1.57 in. to 2.76 in.). If the diameter of the pole is out of this range, please prepare a hose clamp that can hold the pole. The thickness of the hose clamp should be at least 2.5 mm (0.10 in.). The installation site is determined by the technical personnel after a site survey.

Please make sure that the installation site meets the requirements in [2.2 Installation Environment Requirements](#), and observe the following precautions:

- Do not power on the AP during installation.
- Install the AP in a well-ventilated location.
- Do not expose the AP to high temperature.
- Keep the AP away from high-voltage power cables.
- Do not expose the AP to a thunderstorm or strong electric field.
- Cut off the power supply before cleaning the AP.
- Do not open the enclosure when the AP is working.
- Secure the AP tightly.

### 3.4 Installing the AP

---

**⚠ Caution**

- Install the AP in a manner that maximizes the coverage area of the antenna.
  - The schematic diagram provided is for reference purposes only. The actual product should be installed based on its physical specifications and design.
- 

#### 3.4.1 Installing the AP

- (1) Remove the rear cover of the RG-RAP62-OD AP.

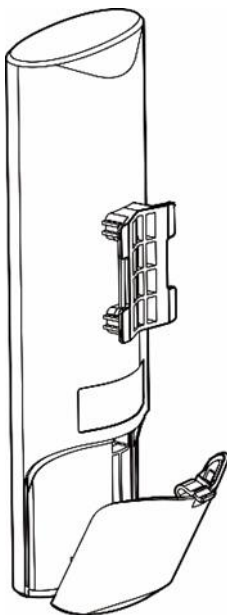

- (2) Insert the Ethernet cable into the LAN/PoE port of the AP.

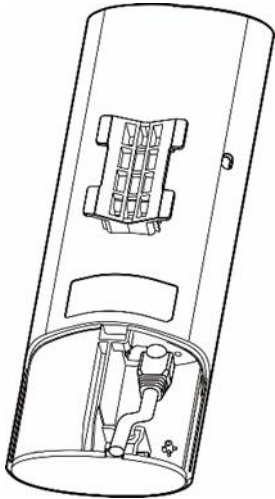

- (3) Install the rear cover.

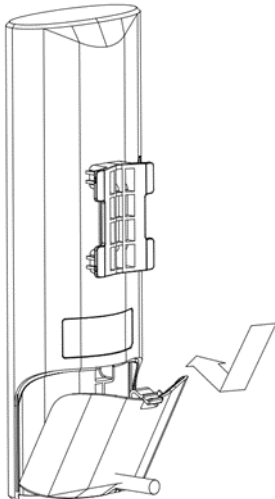

### 3.4.2 Mounting the AP on a Wall

Use the supplied mounting plate, wall anchors, and Philips pan head screws to mount the AP on a wall.

- (1) Drill two screw holes on the wall, with a distance of  $54 \pm 0.5$  mm ( $2.13 \pm 0.02$  in.). Then, insert a wall anchor into each screw hole.

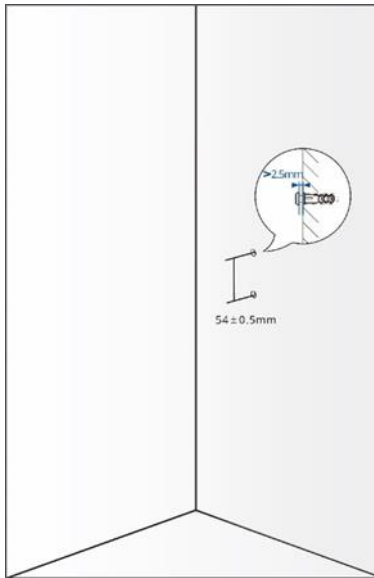

- (2) Fix the mounting plate to the wall (pay attention to the orientation of the mounting plate). After adjusting the installation position, use two Philips pan head screws to secure the mounting plate to the wall.

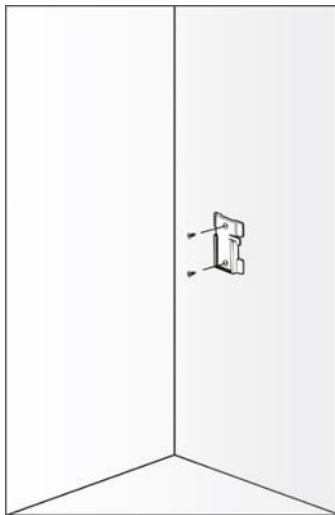

- (3) Align the slots on the back of the AP with the square feet on the mounting plate, and slide the AP into the mounting plate slowly to ensure that the AP is securely fixed.

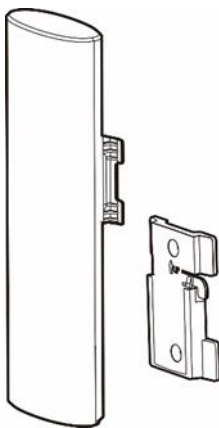

### 3.4.3 Mounting the AP on a Pole

- (1) Take out two cable ties and thread them through the square holes on the back of the AP.

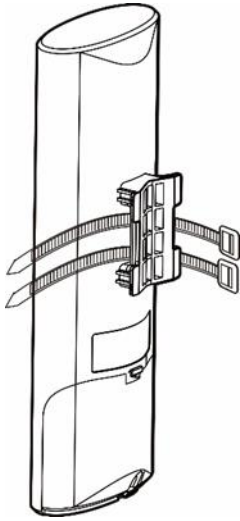

- (2) Press the AP against on the pole, and tighten the cable ties.

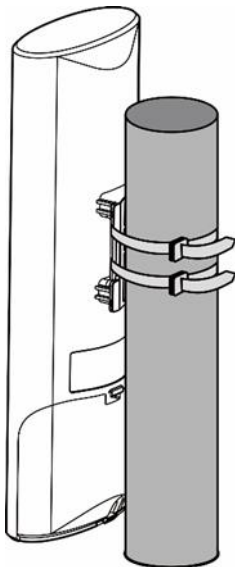

## 3.5 Bundling Cables

### 3.5.1 Precautions

- The power cord and other cables should be neatly bundled.
- Make sure that the fibers at the connectors have natural bends or bends of large radius.
- Do not bind fibers and twisted pair cables too tightly, as this may press the fibers and affect their service life and transmission performance.

### 3.5.2 Bundling Steps

- (1) Bundle the drooping part of the cables and place the bundle as near the ports as possible.

- (2) Secure the cables in the cable management trough of the mounting plate.
- (3) Route the cables under the AP and run them in straight line.

## 3.6 Checklist After Installation

- (1) Checking the AP
  - Verify that the external power supply matches with the requirement of the AP.
  - Verify that the AP is securely fastened.
- (2) Checking Cable Connections
  - Verify that the UTP/STP cable matches with the port type.
  - Verify that the cables are properly bundled.
- (3) Checking Power Supply
  - Verify that the power cord is properly connected and meets safety requirements.
  - Verify that the AP works properly when powered by the power supply.

# 4 Debugging

## 4.1 Setting Up the Configuration Environment

Power on the AP using a standard PoE or 24 V passive PoE adapter.

- Verify that the power cord is properly connected and compliant with safety requirements.
- Connect the AP to the PC using an Ethernet cable.

## 4.2 Powering on the AP

### 4.2.1 Checklist Before Power-On

- The AP is properly grounded.
- The power cord is properly connected.
- The input voltage meets the requirement.

### 4.2.2 Checklist After Power-on

- Verify that there is system log printed on the terminal interface.
- Verify the LED status.

## 4.3 Logging in to the Web GUI

- (1) Power on the PC and configure the local connection attribute on the PC. Set the IP address of the PC to 10.44.77.XXX (1 to 255, excluding 254).

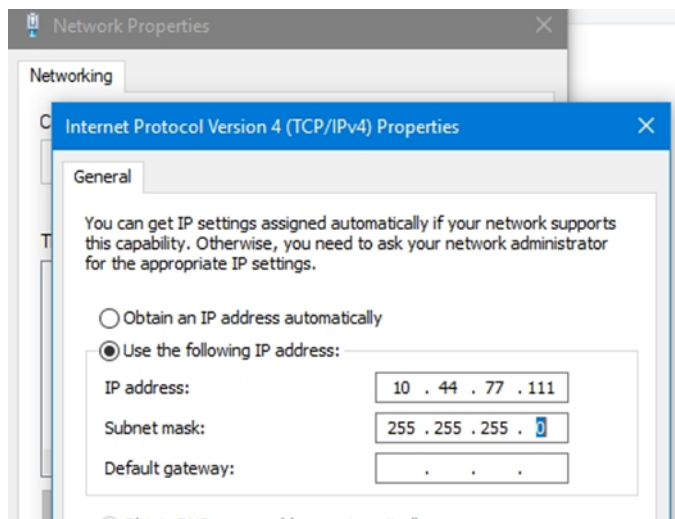

- (2) Open a browser on the PC and enter 10.44.77.254 to log in to the web interface. The default password is admin for the first login. For security purposes, change the default password after login.



# 5 Monitoring and Maintenance

## 5.1 Monitoring

When RG-RAP62-OD is operating, you can monitor its status by observing the LEDs.

## 5.2 Maintenance

If the hardware is faulty, please contact the local distributor.

# 6 Troubleshooting

## 6.1 General Troubleshooting Flowchart

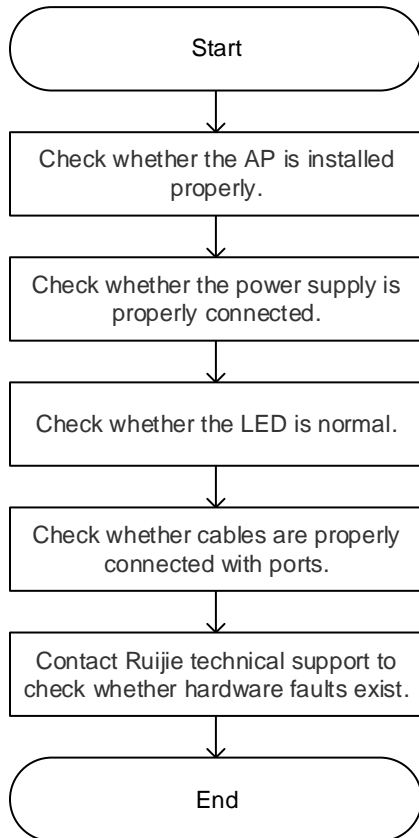

## 6.2 Common Faults

- The status LED is off after the AP is powered on.
  - If the AP is powered by a standard PoE power source, verify that the PSE is IEEE 802.3af-compliant and that the Ethernet cable is properly connected.
  - If the AP is powered by a 24 V passive PoE adapter, verify that the power output specifications of the adapter are 24 V/1 A.
- The Ethernet port does not work after the Ethernet cable is connected.

Verify that the device at the other end of the Ethernet cable is working properly. Then, verify that the cable is capable of providing the required data rate and is properly connected.
- A client cannot discover the AP.
  - Verify that the AP is properly powered.
  - Verify that the Ethernet port is correctly connected.
  - Verify that the AP is correctly configured.

- Move the client device closer to the AP.

# 7 Appendixes

## 7.1 Connectors and Media

### 7.1.1 2500BASE-T/1000BASE-T/100BASE-TX

The 2500BASE-T/1000BASE-T/100BASE-TX port is a 100/1000/2500 Mbps port that supports auto MDI/MDIX Crossover.

Compliant with the IEEE 802.3bz standard, 2500BASE-T requires a Category 6 (Cat 6) or Category 5e (Cat 5e) 100-ohm UTP or STP (recommended) cable with a maximum distance of 100 meters (328 feet). When PoE power supply is used at the same time, a CAT6 STP cable is recommended, and both the port and cable should be properly shielded.

Compliant with the IEEE 802.3ab standard, 1000BASE-T port requires a Cat 6 or Cat 5e 100-ohm UTP or STP (recommended) cable with a maximum distance of 100 meters (328 feet). When PoE power supply is used at the same time, a CAT6 STP cable is recommended, and both the port and cable should be properly shielded.

The 2500BASE-T/1000BASE-T port requires four pairs of wires to be connected for data transmission. Figure 7-1 shows the four pairs of wires for the 2500BASE-T/1000BASE-T port.

**Figure 7-1 2500BASE-T/1000BASE-T Twisted Pair Connections**

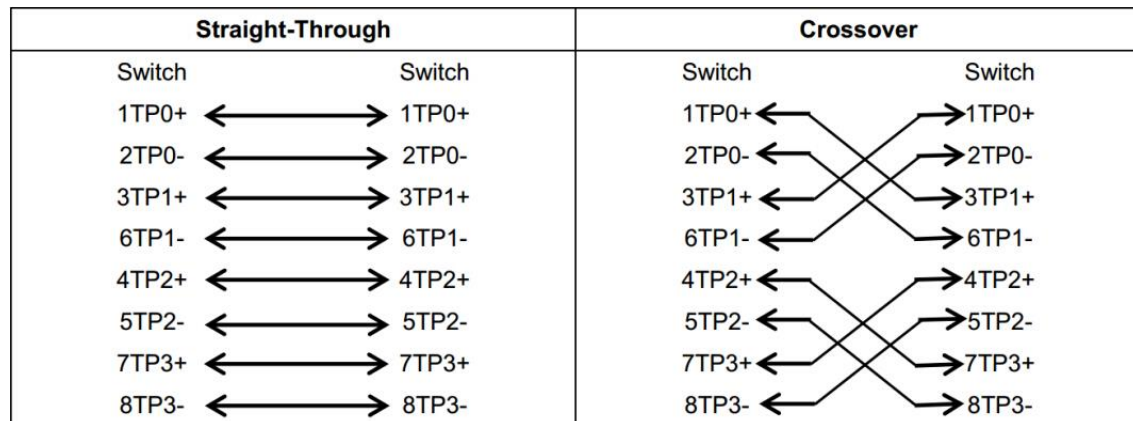

The 100BASE-TX port can be connected using 100-ohm Category 5 (Cat 5) cables with a maximum distance of 100 meters (328 ft.). Table 7-1 shows 100BASE-TX pin assignments.

**Table 7-1 100BASE-TX Pin Assignments**

Pin	Socket	Plug
1	Input Receive Data+	Output Transmit Data+
2	Input Receive Data-	Output Transmit Data-
3	Output Transmit Data+	Input Receive Data+
6	Output Transmit Data-	Input Receive Data-

Pin	Socket	Plug
4, 5, 7, 8	Not Used	Not Used

Figure 7-2 show feasible connections of the straight-through and crossover twisted pairs for a 100BASE-TX port.

**Figure 7-2 100BASE-TX Twisted Pair Connection**

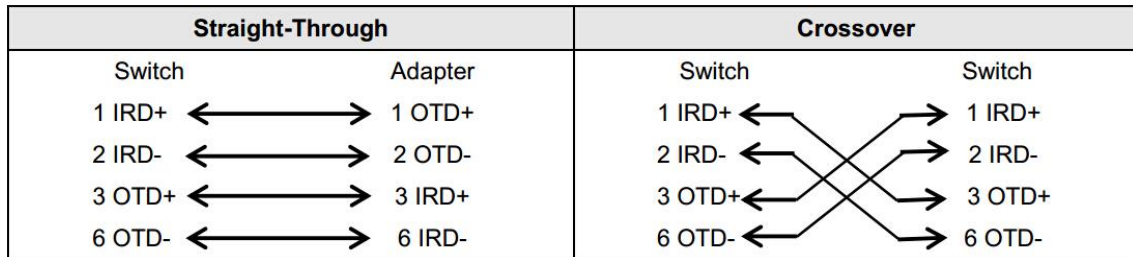

## 7.2 Cabling Recommendations

During installation, route cable bundles upward or downward along the sides of the rack depending on the actual situation in the equipment room. All cable connectors used for transit should be placed at the bottom of the cabinet rather than be exposed outside of the cabinet. Power cords are routed beside the cabinet, and top cabling or bottom cabling is adopted according to the actual situation in the equipment room, such as the positions of the DC power distribution box, AC socket, or lightning protection box.

### Requirements for Cable Bend Radius

- The bend radius of a fixed power cord, network cable, or flat cable should be over five times greater than their respective diameters. The bend radius of these cables that are often bent or plugged should be over seven times greater than their respective diameters.
- The bend radius of a fixed common coaxial cable should be over seven times greater than its diameter. The bend radius of the common coaxial cable that is often bent or plugged should be over 10 times greater than its diameter.
- The bend radius of a fixed high-speed cable (such as an SFP+ cable) should be over five times greater than its diameter. The bend radius of the fixed high-speed cable that is often bent or plugged should be over 10 times greater than its diameter.

### Precautions for Bundling up Cables

- Before cables are bundled, mark labels and stick the labels to cables wherever appropriate.
- Cables should be neatly and properly bundled in the rack without twisting or bending, as shown in Figure 7-3.

**Figure 7-3 Bundling up Cables (1)**

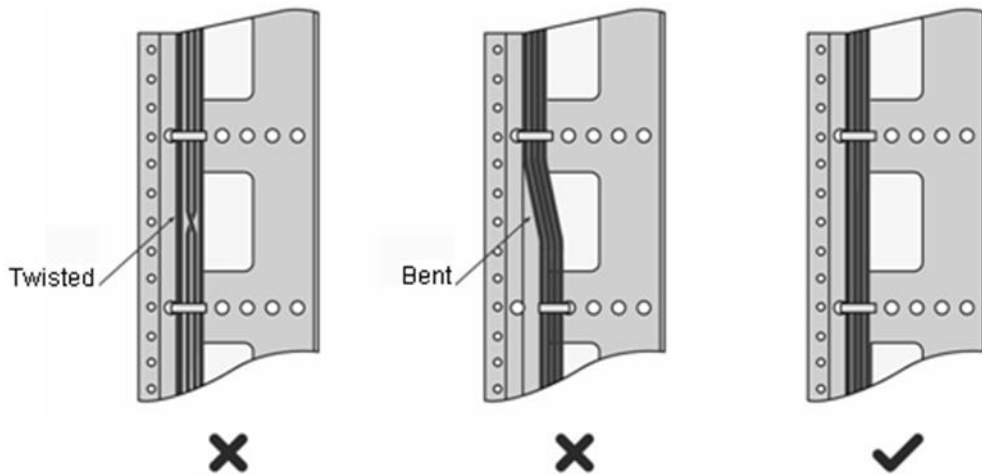

- Cables of different types (such as power cords, signal cables, and grounding cables) should be separated in cabling and bundling. Mixed bundling is disallowed. When they are close to each other, you are advised to adopt crossover cabling. In the case of parallel cabling, maintain a minimum distance of 30 mm (1.18 in.) between power cords and signal cables.
- The cable management brackets and cabling troughs inside and outside the cabinet should be smooth without sharp corners.
- The metal hole traversed by cables should have a smooth and fully rounding surface or an insulated lining.
- Use cable ties to bundle up cables properly. Do not connect two or more cable ties to bundle up cables.
- After bundling up cables with cable ties, cut off the remaining part. The cut should be smooth and trim, without sharp corners, as shown in Figure 7-4.

**Figure 7-4 Bundling up Cables (2)**

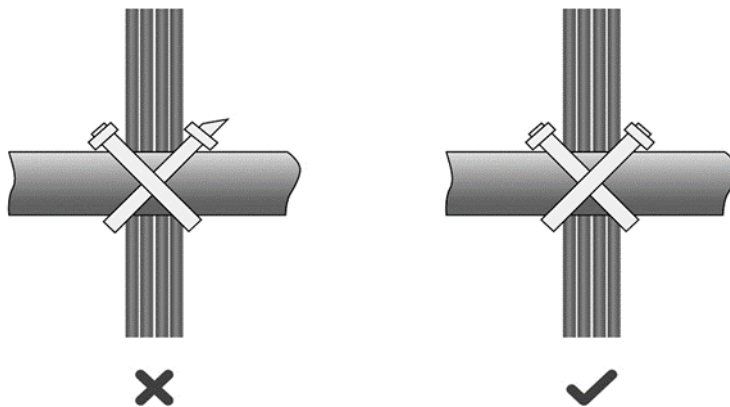

- When cables need to be bent, you should first bundle them up, as shown in Figure 7-5. However, the buckle cannot be bundled within the bend area. Otherwise, considerable stress may be generated in cables, breaking cable cores.

Figure 7-5 Bundling up Cables (3)

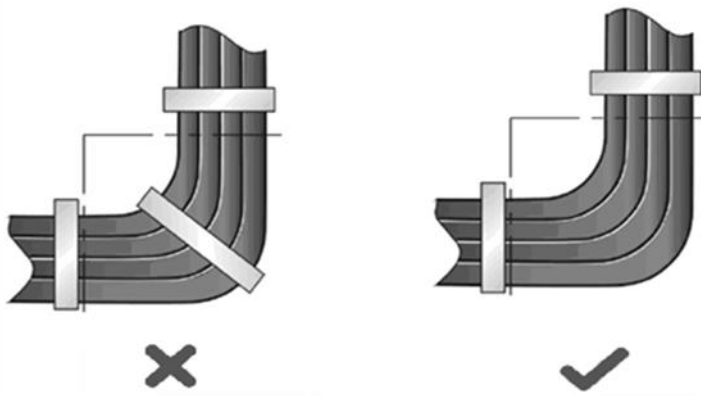

- Cables not to be assembled or remaining parts of cables should be folded and placed in a proper position of the rack or cable trough. The proper position refers to a position that does not affect device running or damage the device or cable.
- 220 V and -48 V power cords must not be bundled on the guide rails of moving parts.
- The power cords connecting moving parts such as grounding cables should be reserved with some access after being assembled to avoid suffering tension or stress. After the moving part is installed, the remaining cable part should not touch heat sources, sharp corners, or sharp edges. If heat sources cannot be avoided, high-temperature cables should be used.
- When screw threads are used to fasten cable terminals, the anchor or screw must be tightly fastened, as shown in Figure 7-6.

Figure 7-6 Cable Fastening

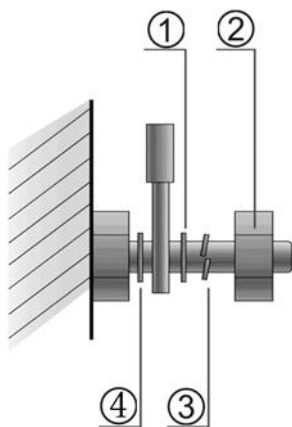

① Flat Washer	③ Spring Washer
② Nut	④ Flat Washer

- Hard power cords should be fastened in the terminal connection area to prevent stress on terminal connection and cable.
- Do not use self-tapping screws to fasten terminals.

- Power cords of the same type and in the same cabling direction should be bundled up into cable bunches, with cables in cable bunches clean and straight.
- Binding by using buckles should be performed according to Table 7-2.

**Table 7-2 Cable Bunch**

<b>Cable Bunch Diameter</b>	<b>Distance between Every Binding Point</b>
10 mm (0.39 in.)	80 mm to 150 mm (3.15 in. to 5.91 in.)
10 mm to 30 mm (0.39 in. to 1.18 in.)	150 mm to 200 mm (5.91 in. to 7.87 in.)
30 mm (1.18 in.)	200 mm to 300 mm (7.87 in. to 11.81 in.)

- No knot is allowed in cabling or bundling.
- For wiring terminal blocks (such as air switches) of the cord end terminal type, the metal part of the cord end terminal should not be exposed outside the terminal block when assembled.